

## DUXS-LH

5/16" WIDE OFFSET SLOT DRAIN W/ 'V'-SHAPED BOTTOM (HIGH-HEEL RATED) WITH HORIZONTAL NO-HUB OUTLET

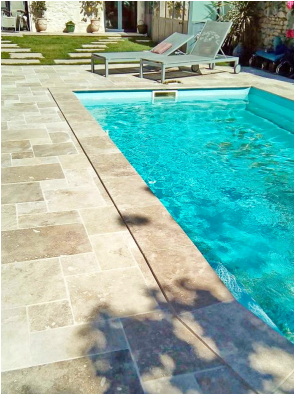

PROJECT: \_\_\_\_\_  
 LOCATION: \_\_\_\_\_  
 APPROVE BY: \_\_\_\_\_ DATE: \_\_\_\_\_

**DESCRIPTION:** 5/16" [8MM] WIDE OFFSET SLOT OPENING WITH V-SHAPE BOTTOM CHANNEL, FOLDED EDGE; 1% PRE-SLOPE; VERTICAL OUTLET; MATERIAL STAINLESS STEEL AISI304, PASSIVATED FINISH.

**PRODUCT ATTRIBUTES:**

APPLICATION: Residential & Commerical  
 MATERIAL: Stainless Steel  
 MATERIAL SPEC: AISI304, 14GA [2mm]  
 FINISH: Passivated  
 BODY TYPE: 'LH' Slot Channel  
 BODY SIZE: BODY SIZE:  
 SLOPE: 1%  
 OUTLET TYPE: Horizontal or Vertical

QUANTITY: \_\_\_\_\_

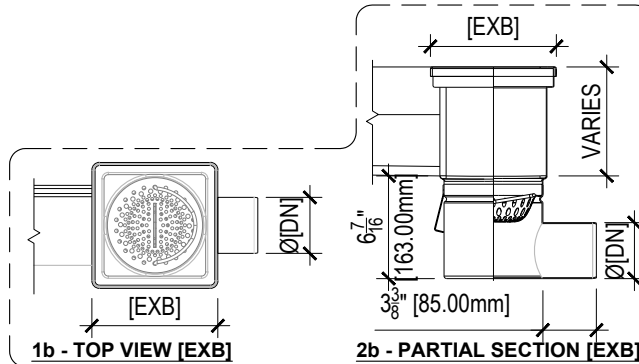
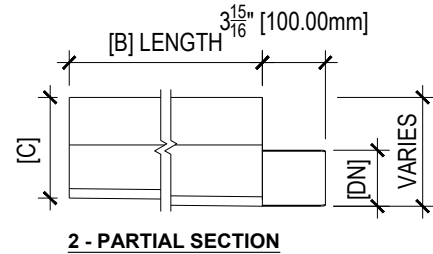
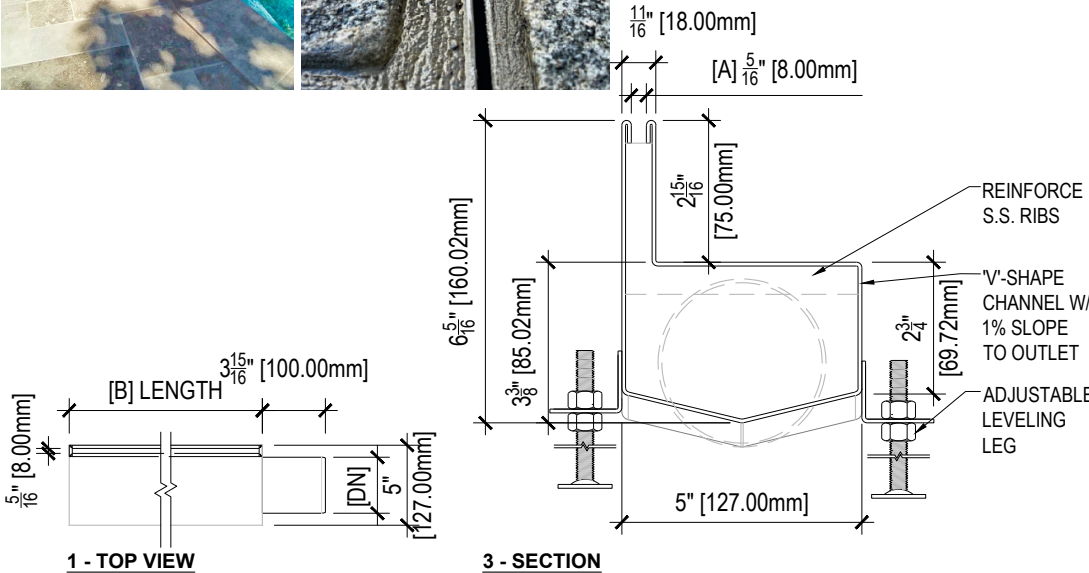

**ACCESSORIES [\*]:**

- FB:** FILTER BASKET
- SB:** SEDIMENT BASKET
- VPG:** GRATE LOCKING SCREWS
- EXB8:** 8"X8" CLEANOUT EXTENSION BOX
- EXB12:** 12"X12" CLEANOUT EXTENSION BOX
- SOR** \_\_\_\_\_": SINGLE (R)IGHT OFFSET OUTLET- \_\_\_\_\_" FOR OUTSIDE EDGE OF CHANNEL [EXB- ONLY]
- SOL** \_\_\_\_\_": SINGLE (L)EFT OFFSET OUTLET- \_\_\_\_\_" FOR OUTSIDE EDGE OF CHANNEL [EXB- ONLY]
- DOR** \_\_\_\_\_"L \_\_\_\_\_": DUAL OFFSET OUTLET- R \_\_\_\_\_" FOR (R)IGHT OUTSIDE EDGE & L \_\_\_\_\_" FOR (L)EFT OUTSIDE EDGE CHANNEL [EXB- ONLY]
- 1/2:** 1/2" [12mm] SLOT OPENING (7/8" [22mm] TOP)
- 316L:** AISI316L STAINLESS STEEL

MODEL SPECIFICATION: DUXS-LH- \_\_\_\_\_ - \_\_\_\_\_ \*

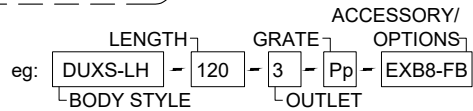

MODEL ID:	OUTLET LOCATION				
	WIDTH [A]	LENGTH [B]	DEPTH [C]	LOCATION [E1]	LOCATION [E2]
<input type="checkbox"/> DUXS-LH	5/16" [8.0]		6 5/16" [160.0]		

- 2:** 2-3/8" [60.0mm] O.D. OF PIPE
- 3:** 3-1/2" [89.9mm] O.D. OF PIPE
- 4:** 4-1/2" [114.3mm] O.D. OF PIPE

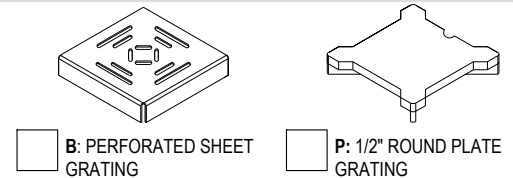

**OUTLET LOCATION:**

- RIGHT END
- CENTER
- LEFT END
- OFFSET (SOR, SOL & DOR/L)

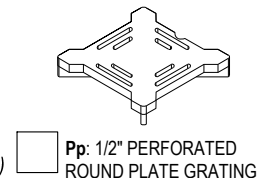

\*\* Refer to custom order form for custom layouts and configurations - Coordinate with sale rep for the lead times\*\*

